

Grommet Mount

for Lustre Desktop Lights

Model GM-LX3-SLV

GM-LX3 Rev A 5/17

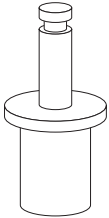

Grommet Mount Post



Gasket

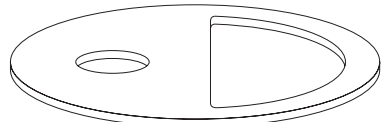

Grommet Mount Plate



Grommet Mount Bar

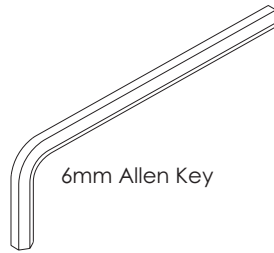

6mm Allen Key

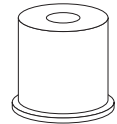

Cap for Post

6mm x 1.0 Bolts

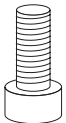

20mm

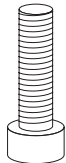

30mm

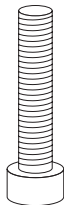

40mm

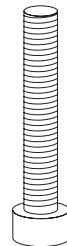

50mm

6mm Washers

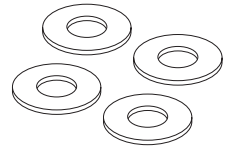

Package Contents:	1 Grommet Mount Post	1 6mm x 1.0 x 20mm Bolt
	1 Gasket	1 6mm x 1.0 x 30mm Bolt
	1 Grommet Mount Plate	1 6mm x 1.0 x 40mm Bolt
	1 Grommet Mount Bar	1 6mm x 1.0 x 50mm Bolt
	1 6mm Allen Key	4 6mm Washers
	1 Cap for Post	

INSTALLATION

STEP 1: CHOOSE BOLT LENGTH

- Measure the thickness of the work surface. Refer to the table below and choose the proper bolt length.

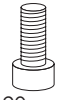
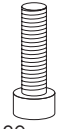
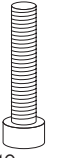
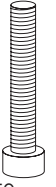
Bolt Length	 20mm	 30mm	 40mm	 50mm
Table Thickness	0.56"-0.91" 14mm-23mm	0.79"-1.3" 20mm-33mm	1.19"-1.7" 30mm-43mm	1.58"-2.09" 40mm-53mm

STEP 2: ASSEMBLE GROMMET MOUNT

- Refer to the illustration and assemble the grommet mount as shown.
- Use as many washers as needed (up to four; one minimum).
- Tighten the bolt securely using the 6mm Allen key.

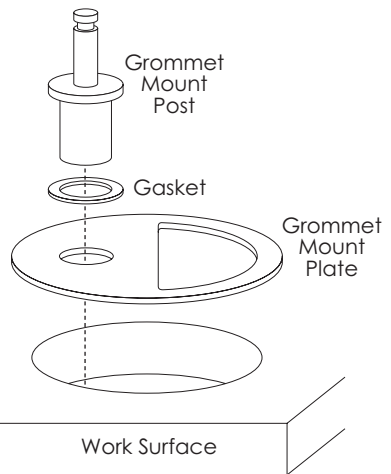
**STEP 3: INSTALL LAMP**

- Insert the bottom of the lamp onto the grommet mount post until it "clicks" into place.

OPTIONAL: INSTALL CAP ON POST

- If the grommet mount is not in use, you may install the cap onto the grommet mount post.

