

CPU-Mini

small profile cpu holder

CPU-Mini

small profile cpu holder



Product specs

- 55.0 lbs. load capacity
- 360° swivel
- 13.4" ball bearing glide track
- 2.7"–6.6" adjustable width
- 16.0"–22.0" adjustable height
- Fits CPUs up to 20.0" in height
- Warranty: 15 yr.



Model

List price

CPUMINI

\$201

Aerial view

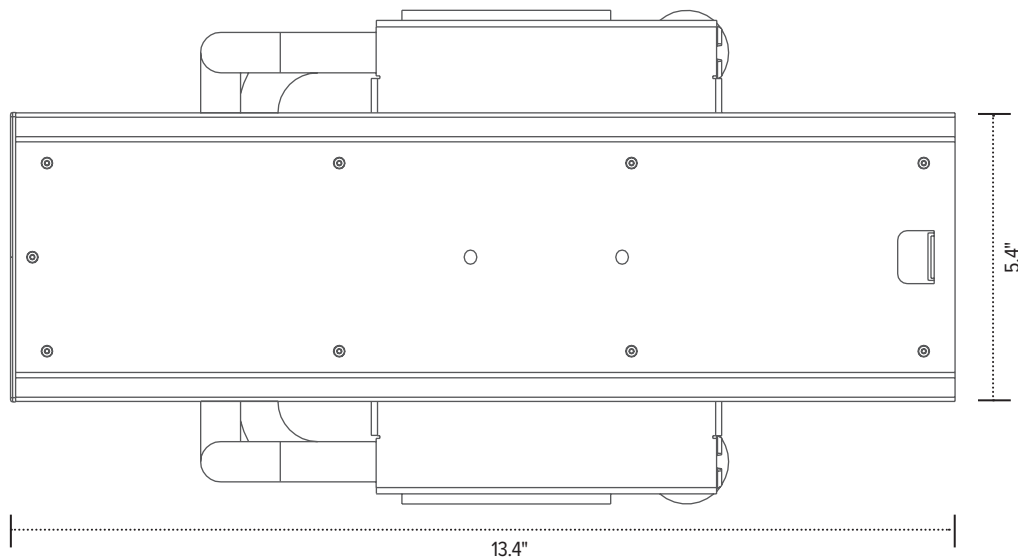

esi

800.833.3746
esiergo.com