

# CLIMB-GM#

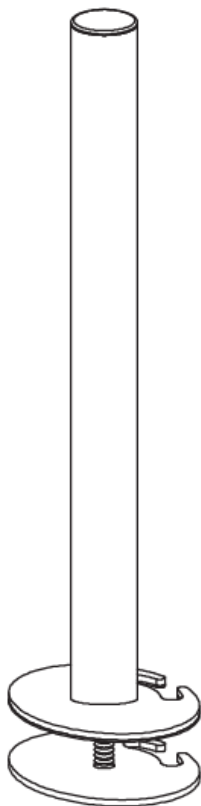





ERGORISE – GROMMET MOUNT FROM CLIMB

VERSION A

INSTRUCTION MANUAL

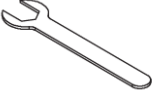

# PARTS LIST

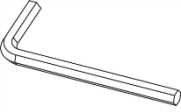
<b>A</b> Top Plate  1 pcs	<b>B</b> Bottom Plate  1 pcs	<b>C</b> Rubber Pad  1 pcs
<b>D</b> M10 x 70 mm Hex Bolt  1 pcs	<b>E</b> Hex Bolt Wrench  1 pcs	<b>F</b> M6 x 30mm Allen Screw  3 pcs
<b>G</b> M6 Allen Wrench  1 pcs		

## STEP 1

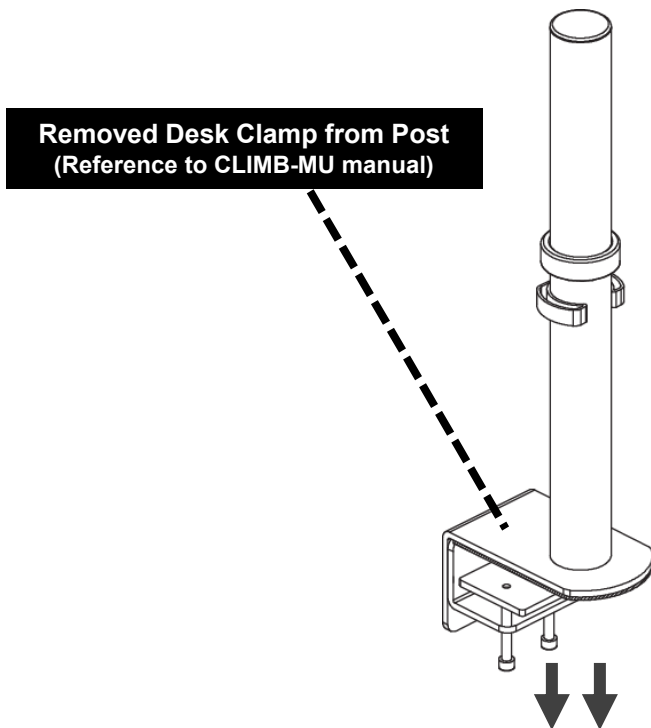

# STEP 2

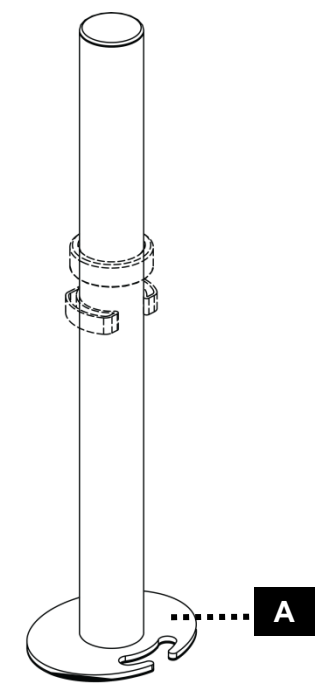
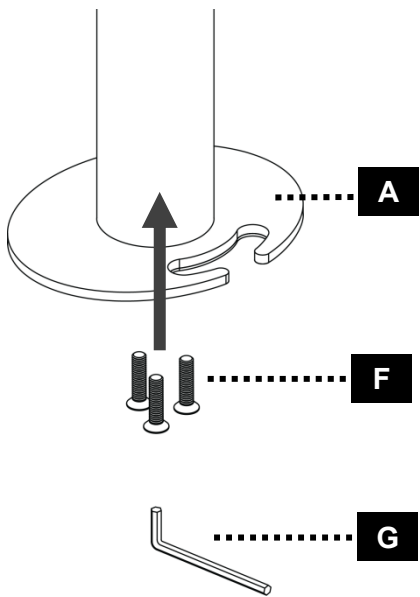

**MAXIMUM**  
Table Thickness  
2.56 inch (65 mm)

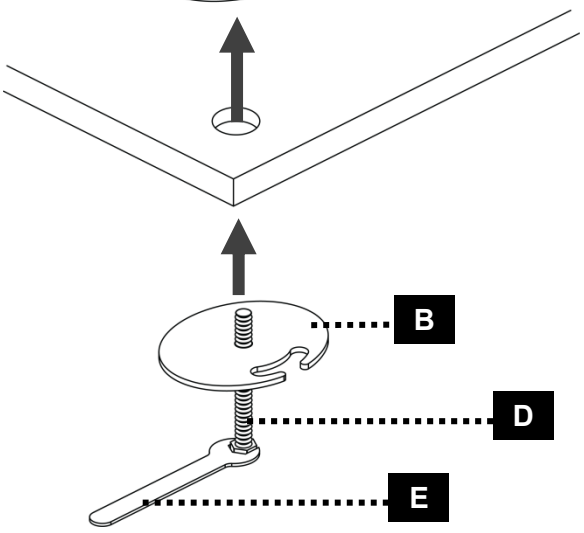



**Phone: 1-800-833-3746**

**Email: [customerservice@esiergo.com](mailto:customerservice@esiergo.com)**

**Web: [www.esiergo.com](http://www.esiergo.com)**